

HP V1910-CMW520-R1111P02  
Release Notes





# HP V1910 Release Notes

Keywords: switch, resolved problems, software upgrading

Abstract: This release notes describes the V1910 release with respect to hardware and software compatibility, released features and functions, software upgrading, and documentation.

Acronyms:

| Acronym | Full spelling                              |
|---------|--|
| ACL     | Access Control List                        |
| CLI     | Command line interface                     |
| DHCP    | Dynamic Host Configuration Protocol        |
| FTP     | File Transfer Protocol                     |
| GARP    | Generic Attribute Registration Protocol    |
| HTTP    | Hypertext Transfer Protocol                |
| ICMP    | Internet Control Message Protocol          |
| IGMP    | Internet Group Management Protocol         |
| IP      | Internet Protocol                          |
| LACP    | Link Aggregation Control Protocol          |
| MIB     | Management Information Base                |
| MSTP    | Multiple Spanning Tree Protocol            |
| NDP     | Neighbor Discovery Protocol                |
| NTP     | Net Time Protocol                          |
| QoS     | Quality of Service                         |
| RADIUS  | Remote Authentication Dial-In User Service |
| RMON    | Remote monitoring                          |
| RSTP    | Rapid Spanning Tree Protocol               |
| SNMP    | Simple Network Management Protocol         |
| SP      | Strict priority                            |
| SSH     | Secure Shell                               |
| STP     | Spanning Tree Protocol                     |
| TFTP    | Trivial File Transfer Protocol             |
| UDP     | User Datagram Protocol                     |
| VLAN    | Virtual Local Area Network                 |



# Contents

- Version information .....4
  - Version number .....4
  - Version history .....4
  - Hardware and software compatibility matrix .....4
- Restrictions and cautions .....6
- Feature list .....6
  - Hardware features .....6
  - Software features .....8
- Version updates .....10
  - Feature updates .....10
  - Command line updates .....11
  - MIB updates .....12
  - Configuration changes .....12
    - Configuration changes in CMW520-R1111P02 .....12
    - Configuration changes in CMW520-R1111P01 .....12
    - Configuration changes in CMW520-R1111 .....12
    - Configuration changes in CMW520-R1109 .....13
    - Configuration changes in CMW520-R1108P01 .....13
    - Configuration changes in CMW520-R1108 .....13
    - Operation changes in CMW520-R1111P01 .....13
    - Operation changes in CMW520-R1111 .....13
    - Operation changes in CMW520-R1109 .....13
    - Operation changes in CMW520-R1108P01 .....13
    - Operation changes in CMW520-R1108 .....13
- Open problems and workarounds .....14
- List of resolved problems .....14
  - Resolved problems in CMW520-R1111P02 .....14
  - Resolved problems in CMW520-R1111P01 .....15
  - Resolved problems in CMW520-R1111 .....15
  - Resolved problems in CMW520-R1109 .....16
  - Resolved problems in CMW520-R1108P01 .....17
  - Resolved problems in CMW520-R1108 .....17
- Related documentation .....18
  - Documentation set .....18
  - Obtaining documentation .....18
- Upgrading software .....18
  - Upgrading at the Boot menu .....19
    - Accessing the Boot menu .....19
    - XMODEM download through the console port .....21
    - TFTP download through an Ethernet port .....30
    - FTP download through an Ethernet port .....32
  - Upgrading at the CLI .....34



## List of Tables

|  |    |
|--|----|
| Table 1 Version history.....                               | 4  |
| Table 2 HP 1910 product family matrix.....                 | 4  |
| Table 3 Hardware and software compatibility matrix.....    | 5  |
| Table 4 V1910 series hardware features .....               | 6  |
| Table 5 Software features of the V1910 series .....        | 8  |
| Table 6 Feature updates .....                              | 10 |
| Table 7 Command line updates .....                         | 11 |
| Table 8 MIB updates.....                                   | 12 |
| Table 9 Documentation set .....                            | 18 |
| Table 10 Approaches to loading software on the switch..... | 18 |
| Table 11 Boot menu options .....                           | 20 |
| Table 12 Description of the TFTP parameters .....          | 30 |
| Table 13 Description of the FTP parameters.....            | 33 |



# Version information

## Version number

Comware software, Version 5.20, Release 1111P02

Note: You can see the version number with the command summary in any view. Please see Note①.

## Version history

Table 1 Version history

| Version number        | Last version          | Release Date | Remarks       |
|-----------------------|-----------------------|--------------|---------------|
| V1910-CMW520-R1111P02 | V1910-CMW520-R1111P01 | 2012-6-19    | None          |
| V1910-CMW520-R1111P01 | V1910-CMW520-R1111    | 2012-3-20    | None          |
| V1910-CMW520-R1111    | V1910-CMW520-R1109    | 2012-1-4     | None          |
| V1910-CMW520-R1109    | V1910-CMW520-R1108P01 | 2011-9-26    | None          |
| V1910-CMW520-R1108P01 | V1910-CMW520-R1108    | 2011-8-17    | None          |
| V1910-CMW520-R1108    | None                  | 2011-5-13    | First release |

## Hardware and software compatibility matrix

Please note that prior to October 2011, these products were shipped under the 3Com Baseline Plus 2900 series brand. The table below shows the mapping between the 3Com 2900 models and HP 1910 switches. Please note that the products are identical except for the branding. HP recommends that customers upgrade to the latest version of software to avail of the new software branding.

Table 2 HP 1910 product family matrix

| HP 1910                      | 3Com 2900                           |
|------------------------------|-------------------------------------|
| 1910-16G : JE005A            | 3Com Baseline Plus Switch 2920      |
| 1910-24G : JE006A            | 3Com Baseline Plus Switch 2928      |
| 1910-24G-PoE (365W) : JE007A | 3Com Baseline Plus Switch 2928 HPWR |
| 1910-24G-PoE (170W) : JE008A | 3Com Baseline Plus Switch 2928 PWR  |
| 1910-48G : JE009A            | 3Com Baseline Plus Switch 2952      |
| 1910-8G : JG348A             | ----                                |
| 1910-8G-PoE+ (65W) : JG349A  | ----                                |



|                              |           |
|------------------------------|-----------|
| HP 1910                      | 3Com 2900 |
| 1910-8G-PoE+ (180W) : JG350A | ----      |

Table 3 Hardware and software compatibility matrix

| Item                        | Specifications   |
|-----------------------------|--|
| Product family              | HP 1910 Switch series  |
| Hardware platform           | HP 1910-16G : JE005A<br>HP 1910-24G : JE006A<br>HP 1910-24G-PoE (365W) : JE007A<br>HP 1910-24G-PoE (170W) : JE008A<br>HP 1910-48G : JE009A<br>HP 1910-8G : JG348A<br>HP 1910-8G-PoE+ (65W) : JG349A<br>HP 1910-8G-PoE+ (180W) : JG350A |
| Minimum memory requirements | 128 MB   |
| Minimum Flash requirements  | 128 MB   |
| Boot ROM version            | Version 155 or higher (Note: Perform the summary command in any view to view the version information. See Note②)   |
| Host software               | V1910-CMW520-R1111P02.bin  |
| iMC version                 | iMC PLAT 5.1 (E0202)<br>iMC QoS 5.1 (E0201)<br>iMC UAM 5.1 (E0301)   |
| iNode version               | iNode PC 5.1 (E0301)   |
| Remarks                     | None   |

```
<HP V1910 Switch>summary
```

```
Select menu option:      Summary
IP Method:              Manual
IP address:             192.168.1.22
Subnet mask:            255.255.255.0
Default gateway:
```

```
Current boot app is: flash:/V1910-CMW520-R1111P02.bin
Next main boot app is: flash:/v1910-cmw520-r1111P01.bin
Next backup boot app is: NULL
```

```
HP Comware Platform Software
```

```
Comware Software, Version 5.20 Release 1111P02, ----- Note①
Copyright (c) 2004-2012 Hewlett-Packard Development Company, L.P.
HP V1910-48G Switch uptime is 0 week, 0 day, 0 hour, 33 minutes
```



HP V1910-48G Switch  
128M bytes DRAM  
128M bytes Nand Flash Memory  
Config Register points to Nand Flash

Hardware Version is REV.B  
CPLD Version is 002  
Bootrom Version is 155 ----- Note②  
[SubSlot 0] 48GE+4SFP Hardware Version is REV.B

## Restrictions and cautions

1. Do not power off the switch during a write operation, such as a save operation.
2. Displaying MAC addresses on a port does not show multicast MAC addresses.
3. Performing VCT check on an up port cannot detect the cable length.
4. The LED for a Gigabit SFP port blinks when the port is receiving packets, and is steady on when the port is sending packets.

## Feature list

### Hardware features

Table 4 V1910 series hardware features

| Item   | Description   |
|--|---|
| Physical dimensions<br>(H × W × D)                                   | 43.6 × 440 × 160 mm (1.72 × 17.32 × 6.30 in.) (V1910-16G)             |
|  | 43.6 × 440 × 160 mm (1.72 × 17.32 × 6.30 in.) (V1910-24G)             |
|  | 43.6 × 440 × 260 mm (1.72 × 17.32 × 10.24 in.) (V1910-48G)            |
|  | 43.6 × 440 × 420 mm (1.72 × 17.32 × 16.54 in.) (V1910-24G-PoE (170W)) |
|  | 43.6 × 440 × 420 mm (1.72 × 17.32 × 16.54 in.) (V1910-24G-PoE (365W)) |
|  | 43.6 × 210 × 210 mm (1.72 × 8.27 × 8.27 in.) (1910-8G)                |
|  | 43.6 × 300 × 260 mm (1.72 × 11.81 × 10.24 in.) (1910-8G-PoE+ (65W))   |
| 43.6 × 300 × 260 mm (1.72 × 11.81 × 10.24 in.) (1910-8G-PoE+ (180W)) |   |



---

|        |  |
|--------|--|
| Weight | ≤ 3 kg (6.61 lb) (V1910-16G)             |
|        | ≤ 3 kg (6.61 lb) (V1910-24G)             |
|        | ≤ 5 kg (11.02 lb) (V1910-48G)            |
|        | ≤ 6 kg (13.22 lb) (V1910-24G-PoE (170W)) |
|        | ≤ 7 kg (15.43 lb) (V1910-24G-PoE (365W)) |
|        | ≤ 2 kg (4.406 lb) (1910-8G)              |
|        | ≤ 3 kg (6.61 lb) (1910-8G-PoE+ (65W))    |
|        | ≤ 3 kg (6.01 lb) (1910-8G-PoE+ (180W))   |

---

|              |   |
|--------------|---|
| Console port | 1 |
|--------------|---|

---

|               |  |
|---------------|--|
| Service ports | 16 × 10/100/1000Base-T autosensing Ethernet ports + 4 GE SFP interfaces (V1910-16G)            |
|               | 24 × 10/100/1000Base-T autosensing Ethernet ports + 4 GE SFP interfaces (V1910-24G)            |
|               | 48 × 10/100/1000Base-T autosensing Ethernet ports + 4 GE SFP interfaces (V1910-48G)            |
|               | 24 × 10/100/1000Base-T autosensing Ethernet ports + 4 GE SFP interfaces (V1910-24G-PoE (170W)) |
|               | 24 × 10/100/1000Base-T autosensing Ethernet ports + 4 GE SFP interfaces (V1910-24G-PoE (365W)) |
|               | 8 × 10/100/1000Base-T autosensing Ethernet ports + 1 GE SFP interfaces (1910-8G)               |
|               | 8 × 10/100/1000Base-T autosensing Ethernet ports + 1 GE SFP interfaces (1910-8G-PoE+ (65W))    |
|               | 8 × 10/100/1000Base-T autosensing Ethernet ports + 1 GE SFP interfaces (1910-8G-PoE+ (180W))   |

---

|               |   |
|---------------|---|
| Input voltage | AC:   |
|               | Rated voltage range: 100 VAC to 240 VAC, 50 Hz or 60 Hz   |
|               | Maximum voltage range: 90 VAC to 264 VAC, 47 Hz or 63 Hz  |
|               | DC:   |
|               | Use the external RPS unit provided by HP only, with the rated voltage ranging from -52 VDC to -55 VDC |
|               | Only V1910-24G-PoE (365W) supports RPS DC input   |

---





---

|  |   |
|--|---|
| Power consumption (full configuration) | 25.1 W (V1910-16G)  |
|  | 31.5 W (V1910-24G)  |
|  | 59.8 W (V1910-48G)  |
|  | 255 W (85 W for system power consumption and 170 W for PoE power consumption) (V1910-24G-PoE (170W))                  |
|  | AC power input: 528 W (158 W for system power consumption and 370 W for PoE power consumption) (V1910-24G-PoE (365W)) |
|  | DC power input: 832 W (92 W for system power consumption and 740 W for PoE power consumption) (V1910-24G-PoE (365W))  |
|  | 14.4 W (1910-8G)  |
| 95 W (1910-8G-PoE+ (65W))              |   |
| 230 W (1910-8G-PoE+ (180W))            |   |
| Operating temperature                  | 0°C to 45°C (32°F to 113°F)   |
| Operating humidity (noncondensing)     | 10% to 90%  |

---

## Software features

Table 5 Software features of the V1910 series

---

| Category               | Features  |
|------------------------|---|
| Link aggregation       | Dynamic aggregation of Gigabit Ethernet (GE) ports<br>Dynamic link aggregation through Link Aggregation Control Protocol (LACP)<br>Manual link aggregation<br>Supports up to (total number of ports/2) link aggregation groups, each supporting up to eight GEs |
| Flow control           | IEEE 802.3x flow control and back pressure  |
| Jumbo Frame            | Maximum frame size of 10 KB   |
| MAC address table      | 8K MAC addresses<br>1K static MAC addresses<br>Blackhole MAC addresses<br>MAC address learning limit on a port  |
| VLAN                   | Port-based VLANs (256 VLANs)<br>Voice VLAN  |
| ARP                    | 256 entries<br>64 static entries  |
| VLAN virtual interface | 8   |

---



| Category                                  | Features   |
|---|--|
| DHCP                                      | DHCP client<br>DHCP snooping<br>DHCP relay agent   |
| Broadcast/multicast/unicast storm control | Storm control based on port rate percentage<br>PPS-based storm control<br>bps-based storm control  |
| MSTP                                      | STP/RSTP/MSTP protocol<br>Up to four spanning tree instances<br>STP root protection<br>BPDU protection   |
| QoS/ACL                                   | 802.1p/DSCP precedence marking<br>Four queues per port<br>SP, WRR, and SP+WRR queue scheduling algorithms<br>Port-based rate limit, with a minimum granularity of 64-kbps<br>Flow-based traffic redirecting<br>Time ranges             |
| Mirroring                                 | Port mirroring   |
| Security features                         | Hierarchical management and password protection of users<br>AAA authentication<br>RADIUS authentication<br>Port isolation<br>802.1X  |
| 802.1X                                    | Up to 1024 users<br>Port-based and MAC address-based authentication<br>Guest VLAN  |
| Loading and upgrade                       | Loading and upgrade through XModem protocol<br>Loading and upgrade through trivial file transfer protocol (TFTP)   |
| Management                                | Simple Network Management Protocol (SNMP)<br>Remote Monitoring (RMON) alarm, event and history recording<br>DM NMS<br>Web NMS<br>System log<br>Hierarchical alarms<br>Stacking management<br>NTP<br>Power, fan, and temperature alarms |
| Maintenance                               | Debugging information output<br>ping and tracer<br>Virtual cable test  |



# Version updates

## Feature updates

Table 6 Feature updates

| Item                     | Description  |
|--------------------------|--|
| V1910-CMW520-R1111P02    |  |
| Hardware feature updates | New features: None<br>Deleted features: None   |
| Software feature updates | New features: None<br>Deleted features: None<br>Modified features: None  |
| V1910-CMW520-R1111P01    |  |
| Hardware feature updates | New features: None<br>Deleted features: None   |
| Software feature updates | New features: None<br>Deleted features: None<br>Modified features: None  |
| V1910-CMW520-R1111       |  |
| Hardware feature updates | New features: Support new devices 1910-8G ,<br>1910-8G-PoE+ (65W) and 1910-8G-PoE+ (180W)<br>Deleted features: None                    |
| Software feature updates | New features: None<br>Deleted features: None<br>Modified features: None  |
| V1910-CMW520-R1109       |  |
| Hardware feature updates | New features: None<br>Deleted features: None   |
| Software feature updates | New features:<br>Gateway settings on the <b>Web-&gt;wizard-&gt;IP Setup</b> page.<br>Deleted features: None<br>Modified features: None |
| V1910-CMW520-R1108P01    |  |
| Hardware feature updates | New features: None<br>Deleted features: None   |
| Software feature updates | New features: None<br>Deleted features: None   |



| Item                     | Description   |
|--------------------------|---|
|                          | Modified features: None   |
| V1910-CMW520-R1108       |   |
| Hardware feature updates | New features: None<br>Deleted features: None                            |
| Software feature updates | New features: None<br>Deleted features: None<br>Modified features: None |

## Command line updates

Table 7 Command line updates

| Item                  | Description |
|-----------------------|-------------|
| V1910-CMW520-R1111P02 |             |
| New commands          | None        |
| Removed commands      | None        |
| Modified commands     | None        |
| V1910-CMW520-R1111P01 |             |
| New commands          | None        |
| Removed commands      | None        |
| Modified commands     | None        |
| V1910-CMW520-R1111    |             |
| New commands          | None        |
| Removed commands      | None        |
| Modified commands     | None        |
| V1910-CMW520-R1109    |             |
| New commands          | None        |
| Removed commands      | None        |
| Modified commands     | None        |
| V1910-CMW520-R1108P01 |             |
| New commands          | None        |
| Removed commands      | None        |
| Modified commands     | None        |
| V1910-CMW520-R1108    |             |
| New commands          | None        |
| Removed commands      | None        |



| Item              | Description |
|-------------------|-------------|
| Modified commands | None        |

## MIB updates

Table 8 MIB updates

| Item                  | MIB file | Module | Description |
|-----------------------|----------|--------|-------------|
| V1910-CMW520-R1111P02 |          |        |             |
| New                   | None     | None   | None        |
| Modified              | None     | None   | None        |
| V1910-CMW520-R1111P01 |          |        |             |
| New                   | None     | None   | None        |
| Modified              | None     | None   | None        |
| V1910-CMW520-R1109    |          |        |             |
| New                   | None     | None   | None        |
| Modified              | None     | None   | None        |
| V1910-CMW520-R1108P01 |          |        |             |
| New                   | None     | None   | None        |
| Modified              | None     | None   | None        |
| V1910-CMW520-R1108    |          |        |             |
| New                   | None     | None   | None        |
| Modified              | None     | None   | None        |

## Configuration changes

### Configuration changes in CMW520-R1111P02

None

### Configuration changes in CMW520-R1111P01

None

### Configuration changes in CMW520-R1111

None



## Configuration changes in CMW520-R1109

1. Merge the ".xml" configuration into the ".cfg" configuration.
2. The Key can be auto-generated for the SSH service on the **Web->Network->Service** page.
3. The PKI certificate can be auto-generated for HTTPS service on the **Web->Network->Service** page.

## Configuration changes in CMW520-R1108P01

None

## Configuration changes in CMW520-R1108

None

## Operation changes in CMW520-R1111P01

After you downgrade a V1910 switch from Release R1111P01 or above to an earlier version than Release R1111P01, its SysOid changes to identify the switch as a 3COM 2900 device, but the change does not affect the use of the switch. For the HP V1910 and 3Com 2900 switch mapping, see "HP V1910 product family matrix."

## Operation changes in CMW520-R1111

None

## Operation changes in CMW520-R1109

None

## Operation changes in CMW520-R1108P01

None

## Operation changes in CMW520-R1108

None



## Open problems and workarounds

### LSD071628

- First found-in version: CMW520-R1111P02
- Description: Connect a 1G port of an 1910 switch to a device that for example uses the RTL8169 network chip of RealTek. The 1G port goes up and down twice, and then goes up.
- Workaround: none.

### LSD44945

- First found-in version: CMW520-R1108
- Description: In the following network diagram, all V1910s and the PC are in the same subnet. MSTP is configured to avoid loops and all V1910s belong to instance 0. Shut down G1/0/49 of the Root Bridge (V1910\_2 in this illustration) and ping V1910\_1 from the PC. The ping breaks off for about 30s.

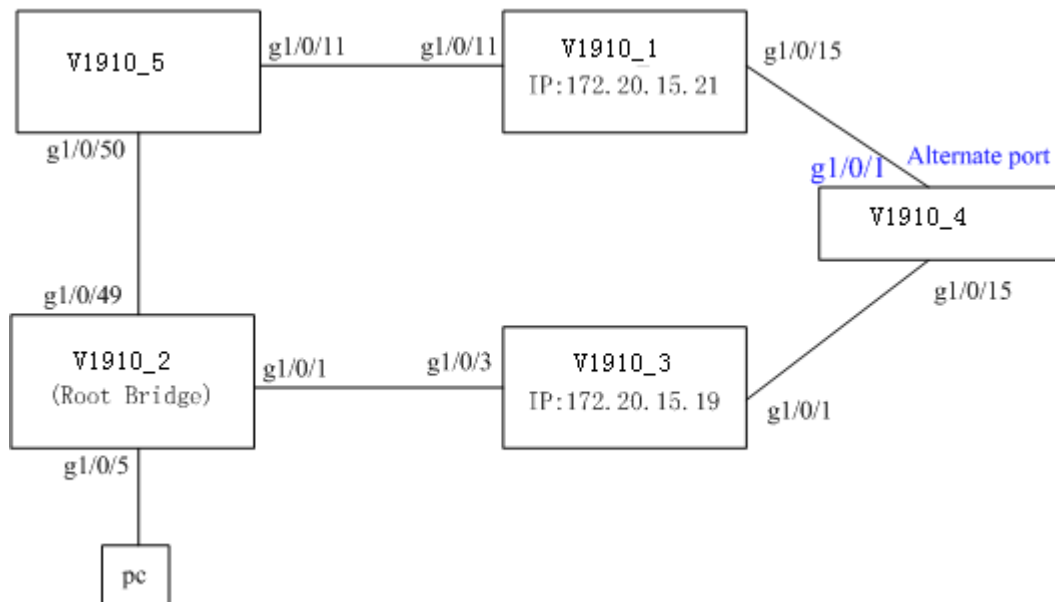

- Workaround: Configure the stp no-agreement-check command on the root ports.

## List of resolved problems

### Resolved problems in CMW520-R1111P02

#### LSD071600

- First found-in version: CMW520-R1111P01
- Condition: Connect a 1G port of an 1910 switch to a device that uses the RTL8169 network chip of RealTek.



- Description: The 1G port repeatedly goes up and down.

## Resolved problems in CMW520-R1111P01

None

## Resolved problems in CMW520-R1111

### LSD65011

- First found-in version: CMW520-R1109
- Condition: View neighbor information in the web page Network > LLDP > Neighbor Summary.
- Description: The web page displays garbage characters.

### LSD64981

- First found-in version: CMW520-R1109
- Condition: Configure a gateway multiple times in the Wizard web page.
- Description: A newly configured gateway cannot overwrite the previous one.

### LSD47162

- First found-in version: CMW520-R1108
- Condition: Using IMC to assign QoS configuration fails.
- Description: IMC does not display error prompt information.

### LSD50868

- First found-in version: CMW520-R1108
- Condition: Configure IGMP snooping in the web page Network > IGMP Snooping.
- Description: The web page is not easy to use.

### LSD50752

- First found-in version: CMW520-R1108
- Condition: The V1910-48G switch perform an inter-chip forwarding. (Ports 1 through 24 belong to a chip; ports 25 through 48 belong to the other chip.)
- Description: Packets with a length of 10K cannot be forwarded.

### LSD64667

- First found-in version: CMW520-R1108P01
- Condition: Use SNMPtest SHA-3DES mode to access the device.
- Description: The CLI of the device does not respond.

### ZDD04517

- First found-in version: CMW520-R1109
- Condition: Use NQA to perform continuous and fast SNMP operations to get or set RPINGMib.





- Description: An error occurs to DISMAN-PING-MIB::pingResultsOperStatus and cannot be recovered. The device may reboot abnormally.

#### ZDD04543

- First found-in version: CMW520-R1109
- Condition: Inject LLDP packets in which the LCI length in the location ID TLV is 0. Then display neighbor information.
- Description: The device reboots abnormally.

#### ZDD04556

- First found-in version: CMW520-R1109
- Condition: Inject LLDP packets with an organization-unknown TLV larger than 500 bytes. After the neighbor relationship is established, display neighbor information.
- Description: The device reboots abnormally.

#### ZDD04569

- First found-in version: CMW520-R1109
- Condition: Issue the debugging vty negotiate command and then perform stress testing.
- Description: Memory application fails and the device reboots.

#### ZDD04596

- First found-in version: CMW520-R1109
- Condition: Inject a large amount of FTP traffic to the device.
- Description: The device reboots abnormally.

#### LSD67635

- First found-in version: CMW520-R1109
- Condition: Read the MIB node entPhysicalHardwareRev.15.
- Description: The displayed information is incorrect.

## Resolved problems in CMW520-R1109

#### LSD63498

- First found-in version: CMW520-R1108
- Condition: Use WEB page.
- Description: The gateway address could not be setup in the wizard.

#### LSD63499

- First found-in version: CMW520-R1108
- Condition: Apply SSH or HTTPS service on the **Web->Network->Service** page.
- Description: The corresponding Key or PKI certificate could not be generated automatically.



#### LSD61667

- First found-in version: CMW520-R1108
- Condition: Use WEB page.
- Description: There is always an “.XML” file.

#### ZDD04165

- First found-in version: CMW520-R1108
- Condition: When the LLDP function is enabled, displays LLDP log information or connects with Cisco IP phone and configures LLDP.
- Description: The LLDP output information contains unrecognized characters in Chassis ID field.

#### ZDD04178

- First found-in version: CMW520-R1108
- Condition: When there exist ARP attacks sending to the device from a single source MAC and the source network different from the interface network.
- Description: Even source MAC based ARP detection is enabled, the ARP packets still can't be filtered by the device

#### ZDD04254

- First found-in version: CMW520-R1108
- Condition: When the device is used as the FTP client, and the prompt of the FTP server is not same as that the RFC suggest.
- Description: The FTP connection could not be created.

## Resolved problems in CMW520-R1108P01

#### LSD63812

- First found-in version: CMW520-R1108
- Condition: The SFP ports work in default configuration (auto negotiation mode).
- Description: The SFP ports cannot linkup or have continually abort input Error.

## Resolved problems in CMW520-R1108

- This is the first release version.



## Related documentation

### Documentation set

Table 9 Documentation set

| Document title  | Version |
|---|---------|
| Read This First (5998-1520)                           | 6P101   |
| HP V1910 Switch Series Compliance and Safety Manual   | 5PW100  |
| HP 1910-8G Switch Series Compliance and Safety Manual | 5PW100  |
| HP 1910 Switch Series Getting Started Guide           | 6W101   |
| HP 1910 Switch Series User Guide-R1111                | 6W100   |

## Obtaining documentation

To find related documents, browse to the Manuals page of the HP Business Support Center website:

<http://www.hp.com/support/manuals>

## Upgrading software

You can access the Boot menu or CLI to download system software and Boot ROM images to Flash memory by using XMODEM, TFTP, or FTP.

Table 10 Approaches to loading software on the switch

| Approach                   | Section  |
|----------------------------|--|
| Upgrading at the Boot menu | <a href="#">XMODEM download through the console port</a> |
|                            | <a href="#">TFTP download through an Ethernet port</a>   |
|                            | <a href="#">FTP download through an Ethernet port</a>    |
| Upgrading at the CLI       | <a href="#">Upgrading at the CLI</a>                     |

The system software and Boot ROM images for the HP V1910 Switch Series are packaged in a .bin file. You can download this file to upgrade both Boot ROM and system software, or upgrade only Boot ROM.

The Boot ROM image in the .bin package file comprises a basic section and an extended section. The basic section is the minimum boot image. The extended section enables the Boot ROM to bootstrap the system and upgrade system software.



**!** IMPORTANT:

When upgrading Boot ROM, upgrade both sections to ensure the functionality of the entire system.

## Upgrading at the Boot menu

### Accessing the Boot menu

Power on the switch (for example, an HP V1910-16G Switch), and you can see the following information:

```
Starting.....
*****
*
*          HP V1910-16G Switch BOOTROM, Version 154          *
*
*****
Copyright (c) 2010-2011 Hewlett-Packard Development Company, L.P.
Creation Date       : Mar 19 2012
CPU L1 Cache       : 32KB
CPU Clock Speed    : 333MHz
Memory Size        : 128MB
Flash Size         : 128MB
CPLD Version       : 002
PCB Version        : Ver.B
Mac Address        : 00E0FC003620
```

Press Ctrl-B to enter Extended Boot menu...0

When "Press Ctrl-B to enter Extended Boot menu" appears, press Ctrl + B within five seconds.

Please input BootRom password:

**NOTE:**

- The system by default starts up in normal (full) mode, and you must press Ctrl + B within five seconds to enter the Boot menu. In fast startup mode, you must press Ctrl + B within one second to enter the Boot menu.
- If you fail to press Ctrl + B within the time limit, the system starts decompressing files, and you must restart the switch to access the Boot menu.

At the prompt, enter the Boot ROM password (no password is required by default) to access the Boot menu:

BOOT MENU



1. Download application file to flash
2. Select application file to boot
3. Display all files in flash
4. Delete file from flash
5. Modify BootRom password
6. Enter BootRom upgrade menu
7. Skip current system configuration
8. Set BootRom password recovery
9. Set switch startup mode
0. Reboot

Enter your choice(0-9):

Table 11 Boot menu options

| Item                                  | Description  |
|---------------------------------------|--|
| 1. Download application file to flash | Download a .bin software package file to Flash memory. You can choose this option to upgrade both system software and Boot ROM.  |
| 2. Select application file to boot    | Select the software package file to boot.  |
| 3. Display all files in flash         | Display all files in Flash memory.   |
| 4. Delete file from flash             | Delete files from Flash memory.  |
| 5. Modify BootRom password            | Modify the Boot ROM password.  |
| 6. Enter BootRom upgrade menu         | Access the Boot ROM update menu. You can choose this option to separately upgrade Boot ROM.  |
| 7. Skip current system configuration  | Start the switch with the default empty configuration. This is a one-time operation and does not take effect at the next reboot. You use this option when you forget the console login password.   |
| 8. Set BootRom password recovery      | Disable or enable the Boot ROM password recovery function. By default, Boot ROM recovery is enabled. You can disable this function to protect system security.   |
| 9. Set switch startup mode            | Set the switch in normal (full) or fast startup mode. The system by default starts up in normal (full) mode, and you must press Ctrl + B within five seconds to enter the Boot menu. In fast startup mode, you must press Ctrl + B within one second to enter the Boot menu. |
| 0. Reboot                             | Restart the switch.  |

**NOTE:**

The procedure of upgrading Boot ROM is the same as upgrading system software. This guide takes upgrading Boot ROM as an example.

## XMODEM download through the console port

You can connect a PC or terminal to the console port to download files to the switch by using XMODEM. XMODEM supports 128-byte data packets and provides the reliability mechanisms including checksum, CRC, and retransmissions (up to 10).

### Setting terminal parameters

Run a terminal emulator program on the console terminal, for example, a PC.

The following are the required terminal settings:

- Bits per second—38,400
- Data bits—8
- Parity—None
- Stop bits—1
- Flow control—None
- Emulation—VT100

Follow these steps to set terminal parameters, for example, on a Windows XP HyperTerminal:

- Step 1** Select Start > All Programs > Accessories > Communications > HyperTerminal, and in the Connection Description dialog box that appears, type the name of the new connection in the Name text box and click OK.

Figure 1 Connection description of the HyperTerminal

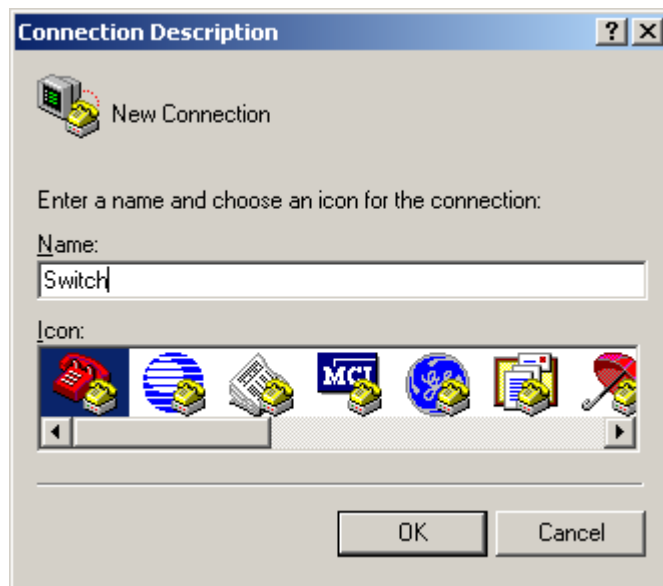

- Step 2** Select the serial port to be used from the Connect using drop-down list, and click OK.

Figure 2 Set the serial port used by the HyperTerminal connection



**Step3** Set Bits per second to 38400, Data bits to 8, Parity to None, Stop bits to 1, and Flow control to None, and click OK.

Figure 3 Set the serial port parameters

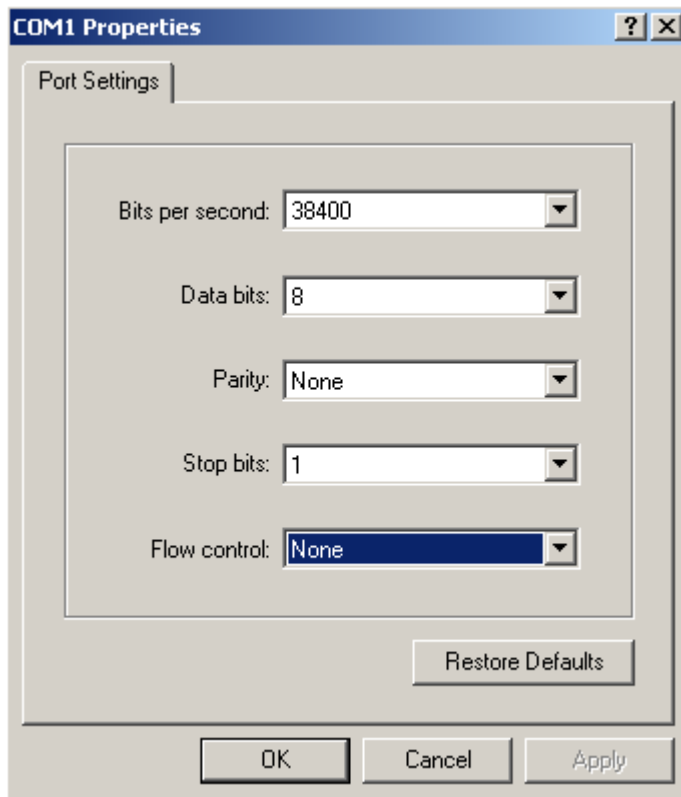

**Step4** Select File > Properties in the HyperTerminal window.



Figure 4 HyperTerminal window

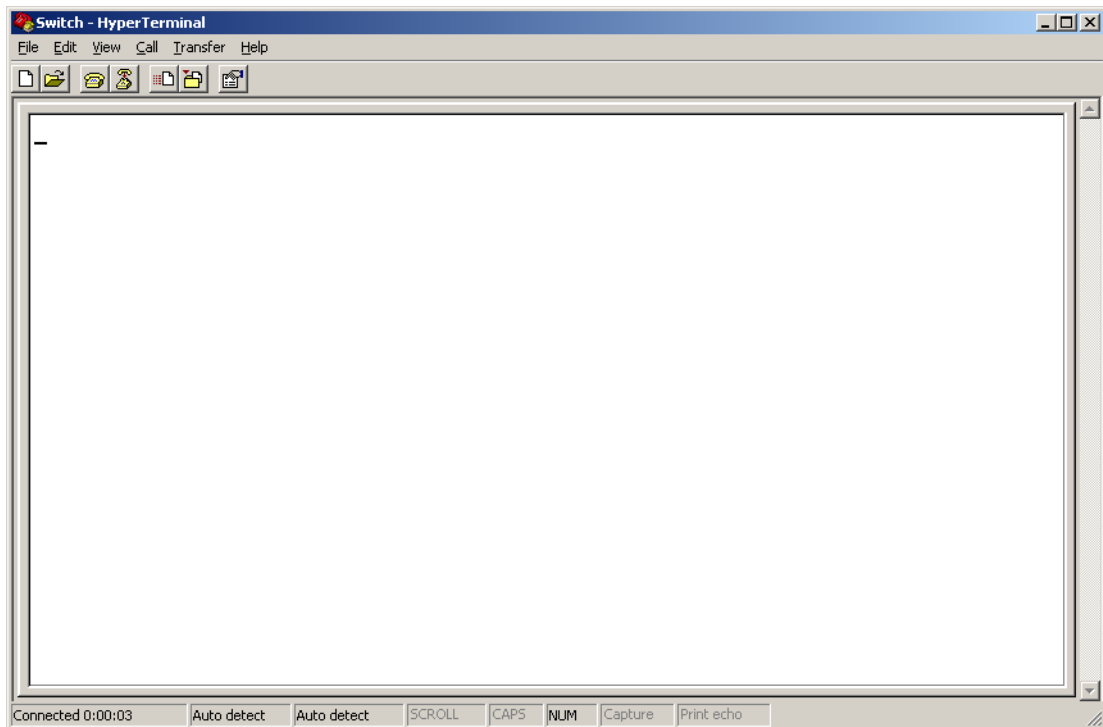

**Step5** Click the Settings tab, set the emulation to VT100, and click OK in the Switch Properties dialog box.



Figure 5 Set terminal emulation in Switch Properties dialog box

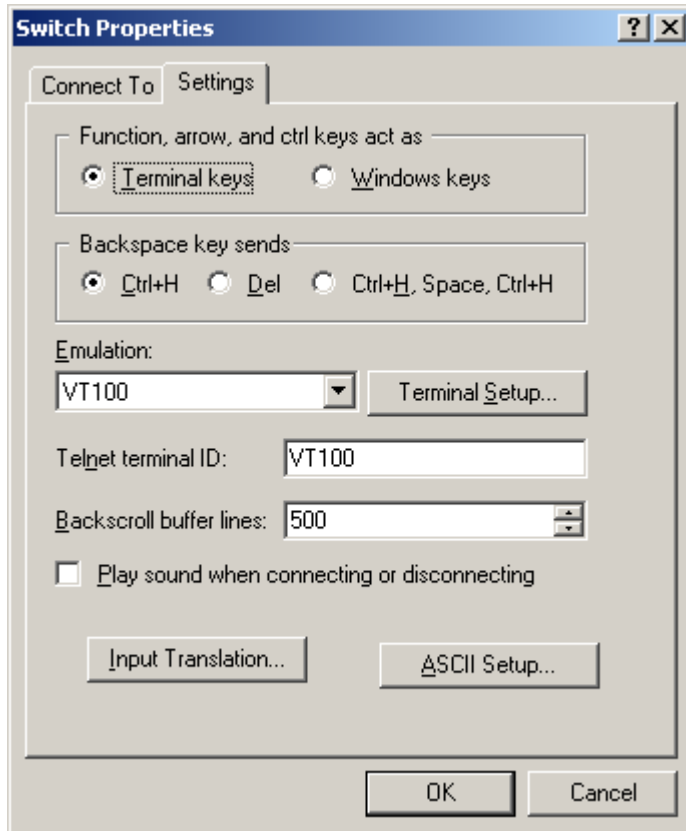

## Upgrading Boot ROM

Perform the following tasks to upgrade Boot ROM by using XMODEM through the console port:

1. Access the Boot menu, and enter 6 or press Ctrl + U to enter the Boot ROM update menu:
  1. Update full BootRom
  2. Update extended BootRom
  3. Update basic BootRom
  0. Return to boot menu

Enter your choice(0-3):

---

### ⓘ IMPORTANT:

Always select option 1 to upgrade the entire Boot ROM. You can use option 2 or option 3 only under the guidance of an HP engineer.

---

2. Enter 1 at the Boot ROM update menu to set the protocol parameters.
  1. Set TFTP protocol parameter
  2. Set FTP protocol parameter
  3. Set XMODEM protocol parameter



0. Return to boot menu

Enter your choice(0-3):

3. Enter 3 to set the XMODEM download baud rate.

Please select your download baudrate:

- 1. 9600
- 2. 19200
- 3. \*38400
- 4. 57600
- 5. 115200
- 0. Return

Enter your choice (0-5):

4. Select an appropriate download rate, for example, enter 5 to select 115200 bps.

Download baudrate is 115200 bps

Please change the terminal's baudrate to 115200 bps and select XMODEM protocol

Press enter key when ready

5. Set the serial port on the terminal to use the same baud rate and protocol as the console port. If you select 38400 bps as the download rate for the console port, skip this task.

**Step1** Select Call > Disconnect in the HyperTerminal window to disconnect the terminal from the switch.

Figure 6 Disconnect the terminal from the switch

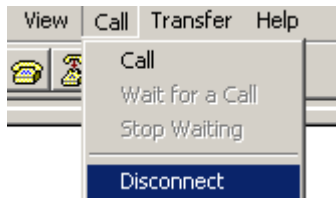

**Step2** Select File > Properties. In the Properties dialog box, click Configure (see [Figure 7](#) ), and then select 115200 from the Bits per second drop-down list box (see [Figure 8](#) ).



Figure 7 Properties dialog box

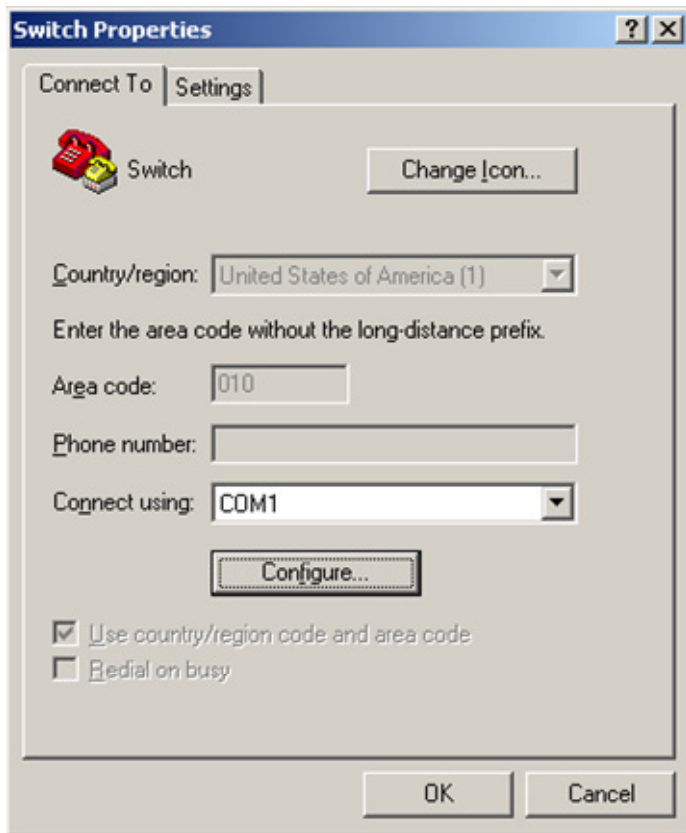
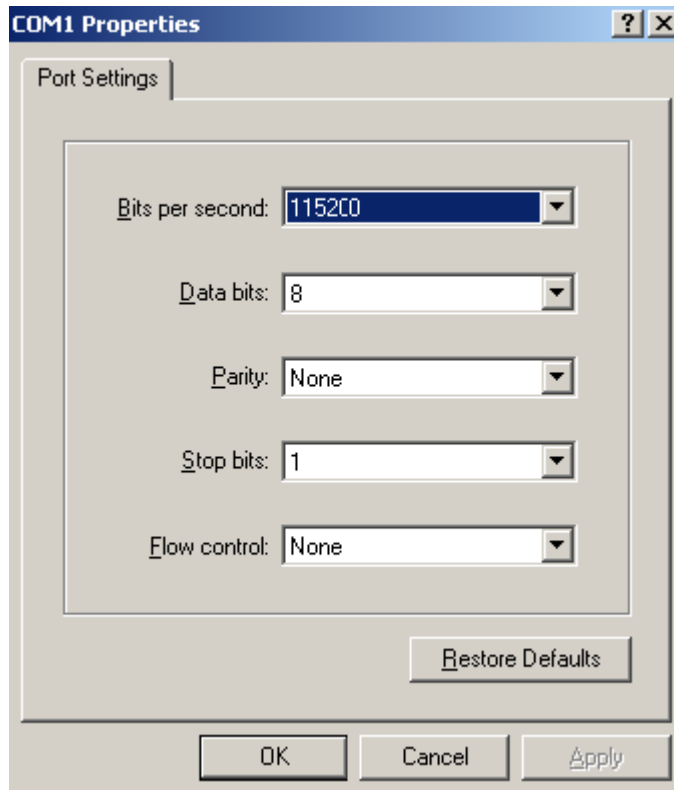
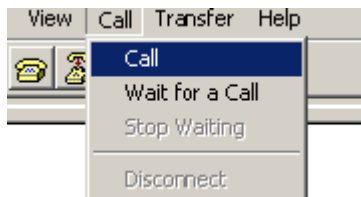

Figure 8 Modify the baud rate



**Step3** Select Call > Call to reestablish the connection.

Figure 9 Reestablish the connection



---

**NOTE:**

The new settings can take effect only after you reestablish the connection.

---

6. Upload the software package file from the terminal to the switch.

**Step4** After establishing a connection between the terminal and the switch, press Enter in the HyperTerminal window.

```
Now please start transfer file with XMODEM protocol.
```

```
If you want to exit, Press <Ctrl+X>.
```

```
Loading ...CCCCCCCCCC
```

**Step5** Select Transfer > Send File in the HyperTerminal window (see [Figure 10](#)), and click Browse in the pop-up dialog box (see [Figure 11](#)) to select the source file (for example, update.bin), and select Xmodem from the Protocol drop-down list.

Figure 10 Transfer menu

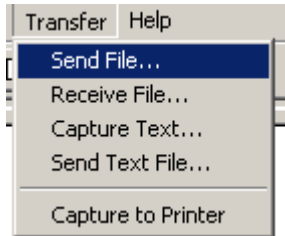
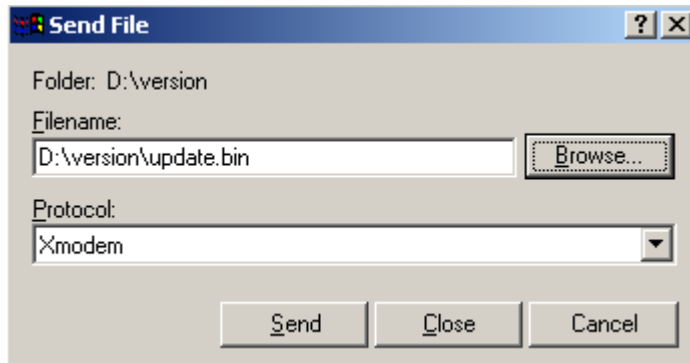
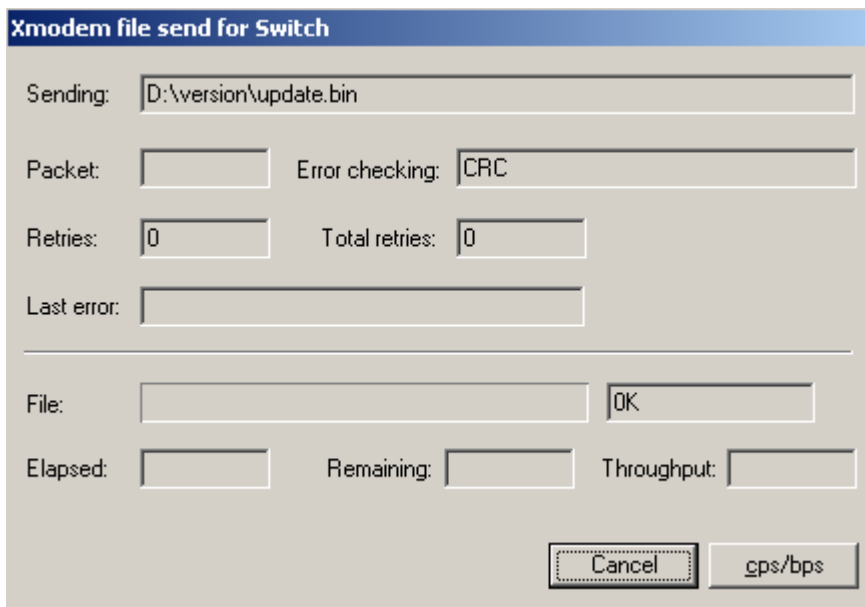

Figure 11 File transmission dialog box



Step 6 Click Send. The following dialog box appears:

Figure 12 Send the application file using XMODEM



7. Upgrade Boot ROM on the switch.

When the terminal displays the following prompt, enter Y to update the basic Boot ROM section:

```
Loading ...CCCC Done!
```



Will you Update Basic BootRom? (Y/N):Y

When the terminal displays the following prompt, enter Y to update the extended Boot ROM section:

Updating Basic BootRom.....Done!

Updating extended BootRom? (Y/N):Y

When the Boot ROM upgrade is completed, the terminal displays the following information:

Updating extended BootRom.....Done!

Please change the terminal's baudrate to 38400 bps, press ENTER when ready.

8. If you are using a download rate other than 38400 bps, restore the baud rate of the serial port on the terminal to 38400 bps. If the baud rate is 38400 bps, skip this step.
9. Press any key to return to the Boot ROM update menu and enter 0. On the Boot menu that appears, enter 0 to restart the switch so the updated image can take effect. The following is the Boot ROM update menu:

1. Update full BootRom
2. Update extended BootRom
3. Update basic BootRom
0. Return to boot menu

Enter your choice(0-3):

## Upgrading system software

To upgrade system software, enter 1 at the Boot menu, and the following menu appears:

1. Set TFTP protocol parameter
2. Set FTP protocol parameter
3. Set XMODEM protocol parameter
0. Return to boot menu

Enter your choice(0-3):

Enter 3 to set the XMODEM parameters for downloading the software package file.

The subsequent procedure is the same as loading Boot ROM images, except that you must set the attribute of the file as main, backup, or none to complete the file loading.

Writing flash.....  
.....Done!

Please input the file attribute (Main/Backup/None) M

Done!

---

### NOTE:

- The switch always attempts to boot first with the main file, and if the attempt fails for example, because the main file is not available, the switch tries to boot with the backup file. A file with the none attribute is just stored in Flash memory for backup and you must change its attribute to make it usable at reboot.
  - If a file with the same attribute as the file you are loading is already in the Flash memory, the attribute of the old file changes to none after the new file becomes valid.
  - The switch automatically updates Boot ROM when loading system software.
-



## TFTP download through an Ethernet port

The switch can work as a TFTP client to download files from a TFTP server.

### Upgrading Boot ROM

1. Connect an Ethernet port of the switch to the server and connect the console port of the switch to a PC

---

#### NOTE:

- The PC and the TFTP/FTP server can be co-located.
  - The HP V1910 Switch Series do not come with any TFTP server program, and you must install one yourself.
- 

2. Run the TFTP server program on the server and specify the source file path.
3. Run a terminal emulator program on the PC, power on the switch, access the Boot menu, and enter 6 to access the following Boot ROM update menu:

- ```
1. Update full BootRom
2. Update extended BootRom
3. Update basic BootRom
0. Return to boot menu
```

Enter your choice(0-3):

4. Enter 1 to upgrade the entire Boot ROM and access the following protocol parameter setting menu:

Bootrom update menu:

- ```
1. Set TFTP protocol parameter
2. Set FTP protocol parameter
3. Set XMODEM protocol parameter
0. Return to boot menu
```

Enter your choice(0-3):

5. Enter 1 to set the TFTP parameters.

Load File Name :update.bin

Server IP Address :10.10.10.2

Local IP Address :10.10.10.3

Gateway IP Address :

Table 12 Description of the TFTP parameters

| Item                 | Description   |
|----------------------|---|
| Load File Name :     | Name of the file to be downloaded (for example, update.bin)         |
| Server IP Address :  | IP address of the TFTP server (for example, 10.10.10.2)             |
| Local IP Address :   | IP address of the switch (for example, 10.10.10.3)                  |
| Gateway IP Address : | IP address of the gateway (in this example, no gateway is required) |



| Item | Description   |
|------|---|
|      | because the server and the switch are on the same subnet) |

**NOTE:**

If the switch and the server are on different subnets, you must specify a gateway address for the switch.

6. Enter all required parameters.

```

Loading.....
.....
.....Done!

```

Will you Update Basic BootRom? (Y/N):Y

Enter Y at the prompt to upgrade the basic Boot ROM section.

Updating Basic BootRom.....Done!

Updating extended BootRom? (Y/N):Y

Enter Y at the prompt to upgrade the extended Boot ROM section.

When the upgrade is completed, the following information appears:

Updating extended BootRom.....Done!

7. Press any key to return to the Boot ROM update menu, enter 0 to return to the Boot menu, and enter 0 to restart the switch from the Boot menu so the upgraded Boot ROM can take effect.

Press enter key when ready

- 1. Update full BootRom
- 2. Update extended BootRom
- 3. Update basic BootRom
- 0. Return to boot menu

Enter your choice(0-3):

### Upgrading system software

To upgrade switch software, enter 1 at the Boot menu to access the following menu:

- 1. Set TFTP protocol parameter
- 2. Set FTP protocol parameter
- 3. Set XMODEM protocol parameter
- 0. Return to boot menu

Enter your choice(0-3):

Enter 1 to set the TFTP parameters.

The subsequent procedure of is the same as upgrading Boot ROM, except that you must set the attribute of the file as main, backup, or none to complete the file loading.

```

Writing flash.....
.....Done!

```

Please input the file attribute (Main/Backup/None) M

Done!



**NOTE:**

- If a file with the same attribute as the file you are loading is already in the Flash memory, the attribute of the old file changes to none after the new file becomes valid.
  - The switch automatically updates Boot ROM when loading system software.
- 

## FTP download through an Ethernet port

The switch can work as an FTP server or FTP client to download files through an Ethernet port. This section uses the switch as an FTP client to describe the procedure.

### Upgrading Boot ROM

---

**NOTE:**

When upgrading Boot ROM, the switch can work only as an FTP client.

---

1. Connect an Ethernet port of the switch to the server and connect the console port of the switch to a PC.
2. Run an FTP server program on the server, configure an FTP username and password, and specify the source file path.
3. Run a terminal emulator program on the PC, power on the switch, access the Boot menu, and enter 6 to access the following Boot ROM update menu:

1. Update full BootRom
2. Update extended BootRom
3. Update basic BootRom
0. Return to boot menu

Enter your choice(0-3):

4. Enter 1 to upgrade the entire Boot ROM and access the following protocol parameter setting menu:

Bootrom update menu:

1. Set TFTP protocol parameter
2. Set FTP protocol parameter
3. Set XMODEM protocol parameter
0. Return to boot menu

Enter your choice(0-3):

5. Enter 2 to set the FTP parameters.

```
Load File Name      :update.bin
Server IP Address   :10.10.10.2
Local IP Address    :10.10.10.3
Gateway IP Address :0.0.0.0
FTP User Name       :V1910
FTP User Password   :V1910
```



Table 13 Description of the FTP parameters

| Item                 | Description  |
|----------------------|--|
| Load File Name :     | Name of the file to be downloaded (for example, update.bin)  |
| Server IP Address :  | IP address of the FTP server (for example, 10.10.10.2)   |
| Local IP Address :   | IP address of the switch (for example, 10.10.10.3)   |
| Gateway IP Address : | IP address of the gateway (in this example, no gateway is required because the server and the switch are on the same subnet) |
| FTP User Name        | Username for accessing the FTP server, which must be the same as configured on the FTP server.                               |
| FTP User Password    | Password for accessing the FTP server, which must be the same as configured on the FTP server.                               |

**NOTE:**

If the switch and the server are on different subnets, you must specify a gateway address for the switch.

## 6. Enter all required parameters.

```
Will you Update Basic BootRom? (Y/N):Y
```

Enter Y at the prompt to upgrade the basic Boot ROM section.

```
Updating Basic BootRom.....Done!
```

```
Updating extended BootRom? (Y/N):Y
```

Enter Y at the prompt to upgrade the extended Boot ROM section.

When the upgrade is completed, the following information appears:

```
Updating extended BootRom.....Done!
```

## 7. Press any key to return to the Boot ROM update menu, enter 0 to return to the Boot menu, and enter 0 to restart the switch from the Boot menu so the upgraded Boot ROM can take effect.

```
Press enter key when ready
```

1. Update full BootRom
2. Update extended BootRom
3. Update basic BootRom
0. Return to boot menu

```
Enter your choice(0-3):
```

**Upgrading system software**

To upgrade switch software, enter 1 in the Boot menu to access the following menu:

1. Set TFTP protocol parameter
2. Set FTP protocol parameter
3. Set XMODEM protocol parameter
0. Return to boot menu

```
Enter your choice(0-3):
```

Enter 2 to set the FTP parameters.



The subsequent procedure is the same as upgrading Boot ROM, except that you must set the attribute of the file as main, backup, or none to complete the file loading.

```
Writing flash.....
.....Done!
Please input the file attribute (Main/Backup/None) M
Done!
```

---

**NOTE:**

- If a file with the same attribute as the file you are loading is already in the Flash memory, the attribute of the old file changes to none after the new file becomes valid.
  - The switch automatically updates Boot ROM when loading system software.
- 

## Upgrading at the CLI

You can remotely download Boot ROM and system software images from a TFTP server at the CLI as follows.

Step 1: Configure an IP address for the switch

```
<HP V1910 Switch>ipsetup ip-address 192.168.1.2 24
```

Step 2: Download the system software image file from the TFTP server.

```
<HP V1910 Switch>upgrade 192.168.1.1 update.bin runtime
```

```
The file flash:/ main.bin exists. Overwrite it? [Y/N]:y
```

```
Verifying server file...
```

```
Deleting the old file, please wait...
```

```
File will be transferred in binary mode
```

```
Downloading file from remote TFTP server, please wait.../
```

```
TFTP: 10262272 bytes received in 104 second(s)
```

```
File downloaded successfully.
```

```
The specified file will be used as the boot file at the next reboot.
```

Step 3: Download and load the Boot ROM file.

```
<HP V1910 Switch>upgrade 192.168.1.1 update.btm bootrom
```

```
File will be transferred in binary mode
```

```
Downloading file from remote TFTP server, please wait...|
```

```
TFTP: 259324 bytes received in 2 second(s)
```

```
File downloaded successfully.
```

```
BootRom file updating finished!
```

Step 4: Reboot the device to validate the new system software.

```
<HP V1910 Switch> reboot
```



Note that if flash memory is insufficient, load the Boot ROM image first and delete useless files to free up Flash memory before you load the system software image.

© Copyright 2012 Hewlett-Packard Development Company, L.P. The information contained herein is subject to change without notice. The only warranties for HP products and services are set forth in the express warranty statements accompanying such products and services. Nothing herein should be construed as constituting an additional warranty. HP shall not be liable for technical or editorial errors or omissions contained herein.